

Logged in as Admin

- » Logout
- » Home
- » Software License
- » Admin Guide
- » FAQs
- » Data Summary
- » Users
 - » New Users
 - » Statistics
- » Abstracts
 - » Statistics
 - » Data Table
 - » Data Checking
- » Payment Proofs
- » Payment Invoice
- » Full Papers
- » Paper Review
 - » Statistics
 - » Data Table
 - » Manage
 - » Result/Action
 - » Archive
- » Revised Papers
- » Copyright Transfers
- » Presentation Video
- » Online Q&A Forum
- » Certificate
 - » Presenter
 - » Non-Presenter
- » Time Series Graphs

:: User profile ::

<< back

No Image Available

Name	Dr. Aceng Sambas [Profiling GS Record Delete User]								
User ID	USER-327 (Activated on Monday, 20 July 2020)								
Email	<input type="text" value="acengs@umtas.ac.id"/>								
Login Code	<input type="text" value="xsZ9BTYban"/>								
Institution	Universitas Muhammadiyah Tasikmalaya								
Research	Dynamical System								
Participation	Presenter								
Postal address	<table style="width: 100%; border-collapse: collapse;"> <tr> <td style="width: 20%;">Street</td> <td>Tamansari Gobras Km. 2.5</td> </tr> <tr> <td>City</td> <td>Tasikmalaya</td> </tr> <tr> <td>ZIP code</td> <td>46196</td> </tr> <tr> <td>Country</td> <td>Indonesia</td> </tr> </table>	Street	Tamansari Gobras Km. 2.5	City	Tasikmalaya	ZIP code	46196	Country	Indonesia
Street	Tamansari Gobras Km. 2.5								
City	Tasikmalaya								
ZIP code	46196								
Country	Indonesia								
Phone number									
Fax number									

Preferred Presentation Schedule: Day 1 - Before Noon

There is no guarantee that your request will be accomodated

[Abstract ID: ABS-219]

[Search on Ifory](#)

Electronic Circuit Design of a Novel Chaotic System with Apple-Shaped Curve Equilibrium and Multiple Coexisting Attractors

A. Sambas1*, Sukono2, S. Zhang3, S. Vaidyanathan4, Y. Hidayat5 and Mujiarto1

1Department of Mechanical Engineering, Universitas Muhammadiyah Tasikmalaya, Tasikmalaya, Indonesia

2Department of Mathematics, Faculty of Mathematics and Natural Sciences, Universitas Padjadjaran, Indonesia

3School of Physics and Opotoelectric Engineering, Xiangtan University, Xiangtan, Hunan, China

4Research and Development Centre, Vel Tech University, Avadi, Chennai, India

5Department of Statistics, Faculty of Mathematics and Natural Sciences, Universitas Padjadjaran, Indonesia

Abstract

A new 3-D chaotic system with an apple-shaped equilibrium curve is proposed in this research work. There is great interest in the literature in discovering chaotic systems with closed curves of equilibrium points. In this work, we report a new 3-D chaotic system with an apple-shaped closed curve of equilibrium points. We perform a detailed dynamic analysis of the chaotic system with bifurcation diagram, Lyapunov exponents, phase portraits, etc. We show that the new chaotic system is multi-stable with coexisting chaotic attractors. As a circuit application, we design MultiSIM electronic circuit for the new chaotic system. The MultiSIM outputs show good agreement with the MATLAB outputs for the new chaotic system. **(Approx. 111 words)**

Keywords: 3-D Chaotic, Apple-Shaped, Curve Equilibrium

Topic: Engineering and Technology

Type: Oral Presentation

Info:

Abstract Review Result

Type: Oral Presentation

Info:

Abstract Review Result

Decision: Accepted

Comment:

[Get Letter of Acceptance](#) [Get Letter of Invitation](#)

[Get Certificate](#)
[See certificate sample](#)

 Need as PDF? Use Chrome Browser, [here is how](#)

Submission Final Decision

Decision: Accepted

Comment:

[Get Letter of Acceptance](#) [Get Letter of Invitation](#)

 Need as PDF? Use Chrome Browser, [here is how](#)

URL JPCS-1477: <https://iopscience.iop.org/volume/1742-6596/1477>

URL pdf: <https://iopscience.iop.org/article/10.1088/1742-6596/1477/2/022015/pdf>

URI abstract: <https://iopscience.iop.org/article/10.1088/1742-6596/1477/2/022015>

Link indexing: <https://www.scimagojr.com/journalsearch.php?q=130053&tip=sid&clean=0>

[Print this page](#)

ICComSET 2019

The 2nd International Conference on Computer, Science,
Engineering and Technology

Universitas Muhammadiyah Tasikmalaya/Banten, 15-16 October 2019

Website: <http://www.2ndiccomset.umtas.ac.id>

Email: iccomset@umtas.ac.id

Date: 16 July 2019

Letter of Acceptance for Abstract

Dear Authors: A. Sambas^{1*}, Sukono², S. Zhang³, S. Vaidyanathan⁴, Y. Hidayat⁵ and Mujiarto¹

We are pleased to inform you that your abstract (ABS-219, Oral Presentation), entitled:

"Electronic Circuit Design of a Novel Chaotic System with Apple-Shaped Curve Equilibrium and Multiple Coexisting Attractors"

has been reviewed and accepted to be presented at ICComSET 2019 conference to be held on 15-16 October 2019, in Banten, Indonesia.

Please submit your full paper and make the payment for registration fee before the deadlines, visit our website for more information.

Thank You.

Best regards,

A handwritten signature in black ink, appearing to be 'Mujiarto', with a horizontal line underneath.

Dr. Mujiarto, S.T.,M.T.
ICComSET 2019 Chairperson

Konfrenzi.com - Conference Management System

Print this page



ICComSET 2019

The 2nd International Conference on Computer, Science,
Engineering and Technology

Universitas Muhammadiyah Tasikmalaya/Banten, 15-16 October 2019

Website: <http://www.2ndiccomset.umtas.ac.id>

Email: iccomset@umtas.ac.id

Date: 11 October 2019

Letter of Acceptance for Full Paper

Dear Authors: A. Sambas^{1*}, Sukono², S. Zhang³, S. Vaidyanathan⁴, Y. Hidayat⁵ and Mujiarto¹

We are pleased to inform you that your paper, entitled:

"Electronic Circuit Design of a Novel Chaotic System with Apple-Shaped Curve Equilibrium and Multiple Coexisting Attractors"

has been reviewed and accepted to be presented at ICComSET 2019 conference to be held on 15-16 October 2019 in Banten, Indonesia.

Please make the payment for registration fee before the deadlines, visit our website for more information.

Thank You.

Best regards,

A handwritten signature in black ink, appearing to be 'Mujiarto', with a horizontal line underneath.

Dr. Mujiarto, S.T.,M.T.
ICComSET 2019 Chairperson

[Print this page](#)

ICComSET 2019

The 2nd International Conference on Computer, Science,
Engineering and Technology

Universitas Muhammadiyah Tasikmalaya/Banten, 15-16 October 2019

Website: <http://www.2ndiccomset.umtas.ac.id>

Email: iccomset@umtas.ac.id

Date: 10 September 2019

Letter of Invitation

Dear Authors: A. Sambas1*, Sukono2 , S. Zhang3 , S. Vaidyanathan4 , Y. Hidayat5 and Mujiarto1

We are pleased to inform you that your abstract (ABS-219, Oral Presentation), entitled:

"Electronic Circuit Design of a Novel Chaotic System with Apple-Shaped Curve Equilibrium and Multiple Coexisting Attractors"

has been reviewed and accepted to be presented at ICComSET 2019 conference to be held on 15-16 October 2019 in Banten, Indonesia.

We cordially invite you to attend our conference and present your research described in the abstract.

Please submit your full paper and make the payment for registration fee before the deadlines, visit our website for more information.

Thank You.

Best regards,

A handwritten signature in black ink, appearing to be 'Mujiarto', with a horizontal line underneath it.

Dr. Mujiarto, S.T.,M.T.
ICComSET 2019 Chairperson

[Print this page](#)

ICComSET 2019

The 2nd International Conference on Computer, Science,
Engineering and Technology

Universitas Muhammadiyah Tasikmalaya/Banten, 15-16 October 2019

Website: <http://www.2ndiccomset.umtas.ac.id>

Email: iccomset@umtas.ac.id

Date: 10 September 2019

Letter of Invitation

Dear Authors: A. Sambas^{1*}, Sukono², S. Zhang³, S. Vaidyanathan⁴, Y. Hidayat⁵ and Mujiarto¹

We are pleased to inform you that your paper, entitled:

"Electronic Circuit Design of a Novel Chaotic System with Apple-Shaped Curve Equilibrium and Multiple Coexisting Attractors"

has been reviewed and accepted to be presented at ICComSET 2019 conference to be held on 15-16 October 2019 in Banten, Indonesia.

We cordially invite you to attend our conference and present your research described in the paper.

Please make the payment for registration fee before the deadlines, visit our website for more information.

Thank You.

Best regards,

A handwritten signature in black ink, appearing to be 'Mujiarto', with a horizontal line underneath.

Dr. Mujiarto, S.T.,M.T.
ICComSET 2019 Chairperson

Konfrenzi.com - Conference Management System

Electronic Circuit Design of a Novel Chaotic System with Apple-Shaped Curve Equilibrium and Multiple Coexisting Attractors

A. Sambas^{1*}, Sukono², S. Zhang³, S. Vaidyanathan⁴, Y. Hidayat⁵ and Mujiarto¹

¹Department of Mechanical Engineering, Universitas Muhammadiyah Tasikmalaya, Tasikmalaya, Indonesia

²Department of Mathematics, Faculty of Mathematics and Natural Sciences, Universitas Padjadjaran, Indonesia

³School of Physics and Optoelectric Engineering, Xiangtan University, Xiangtan, Hunan, China

⁴Research and Development Centre, Vel Tech University, Avadi, Chennai, India ⁵Department of Statistics, Faculty of Mathematics and Natural Sciences, Universitas Padjadjaran, Indonesia

*acengs@umtas.ac.id

Abstract. A new 3-D chaotic system with an apple-shaped equilibrium curve is proposed in this research work. There is great interest in the literature in discovering chaotic systems with closed curves of equilibrium points. In this work, we report a new 3-D chaotic system with an apple-shaped closed curve of equilibrium points. We perform a detailed dynamic analysis of the chaotic system with bifurcation diagram, Lyapunov exponents, phase portraits, etc. We show that the new chaotic system is multi-stable with coexisting chaotic attractors. As a circuit application, we design MultiSIM electronic circuit for the new chaotic system. The MultiSIM outputs show good agreement with the MATLAB outputs for the new chaotic system.

1. Introduction

Chaos theory deals with nonlinear dynamical systems exhibiting high sensitivity to small changes in initial conditions [1-2]. Mathematically, chaotic systems are characterized by the presence of at least one positive Lyapunov exponent.

Chaotic systems with hidden attractors have become a hot topic for discussion. The phenomenon of hidden attractors has been applied in various sciences and techniques such as electronic circuit [3-6], radio-physical oscillator system [7], robotic [8], aircraft flight [9], motor DC [10], and Hopfield neural network [11].

In the chaos literature, some important discoveries related to hidden attractors include chaotic system with no equilibrium point [12], system with stable equilibria [13] and system with infinite number of equilibrium [14-20].

In this research paper, we report the finding of a new chaotic system with an apple-shaped curve of equilibrium points. We analyze the properties of the new chaotic system with the help of phase plots, bifurcation diagrams, Lyapunov exponents, etc.

Multi-stability is an important property associated with some chaotic systems, which is basically the co-existence of chaotic attractors for same parameter set but for different initial conditions [21-24]. It is interesting that the new chaotic system has multi-stability with the coexistence of two chaotic attractors for two different initial states.

Section 2 describes the new chaotic system with apple-shaped equilibrium curve, its phase plots and Lyapunov exponents. Chaotic systems with infinite number of equilibrium points belong to the class of chaotic systems with hidden attractors. Thus, the new chaotic system has hidden chaotic attractor. Section 3 describes the dynamic analysis with bifurcation diagrams, Lyapunov exponents and multi-stability of the new chaotic system. Furthermore, an electronic circuit realization of the new chaotic system is presented using MultiSIM in Section 4. The MutiSIM circuit outputs of the new chaotic system in Section 4 show good agreement with the numerical simulations via MATLAB obtained in Section 2. Section 5 draws the main conclusions.

2. A New Chaotic System with Apple-Shaped Equilibrium

In this work, we report a new 3-D system modelled by

$$\begin{cases} \dot{x} = z \\ \dot{y} = z(-ay - by^2 - xz) \\ \dot{z} = x^4 + y^4 - y|x| - 1 \end{cases} \quad (1)$$

where $X = (x, y, z)$ is the state and a, b are positive constants.

In this paper, we show that the 3-D system (1) is *chaotic* for the parameter values

$$a = 18, b = 1 \quad (2)$$

Using Wolf's algorithm [60], the Lyapunov exponents of the system (1) for the parameter set $(a, b) = (18, 1)$ and the initial state $X(0) = (0.01, 0.02, 0.01)$ were found as

$$LE_1 = 0.0787, LE_2 = 0, LE_3 = -0.0933 \quad (3)$$

It is noted that the sum of the Lyapunov exponents in (3) is negative.

$$LE_1 + LE_2 + LE_3 = -0.0146 < 0 \quad (4)$$

This shows that the system (1) is dissipative with a strange chaotic attractor. The Kaplan-Yorke dimension of the new chaotic system (1) is computed as

$$D_{KY} = 2 + \frac{LE_1 + LE_2}{|LE_3|} = 2.8435 \quad (5)$$

The high value of the Kaplan-Yorke dimension, D_{KY} , shows the high complexity of the chaotic trajectories of the new 3-D system (1).

The equilibrium points of the new chaotic system (1) are found by solving the system of equations:

$$z = 0 \quad (6a)$$

$$z(-ay - by^2 - xz) = 0 \quad (6b)$$

$$x^4 + y^4 - y|x| - 1 = 0 \quad (6c)$$

Solving the equations (6a)-(6c), we see that the new chaotic system (1) has an apple-shaped closed curve of equilibrium points in the (x, y) - plane given by the set

$$S = \left\{ (x, y, z) \in R^3 \mid z = 0, x^4 + y^4 - y|x| - 1 = 0 \right\} \quad (7)$$

Figure 1 shows the apple-shaped equilibrium curve in the (x, y) - plane for the new chaotic system (1). Figure 2 shows the Lyapunov exponents of the 3-D chaotic system (1) for the parameter set

$(a,b) = (18,1)$ and initial state $X(0) = (0.01, 0.02, 0.01)$. Figures 3-5 show the 2-D phase plots for the new chaotic system (1) for $(a,b) = (18,1)$ and $X(0) = (0.01, 0.02, 0.01)$.

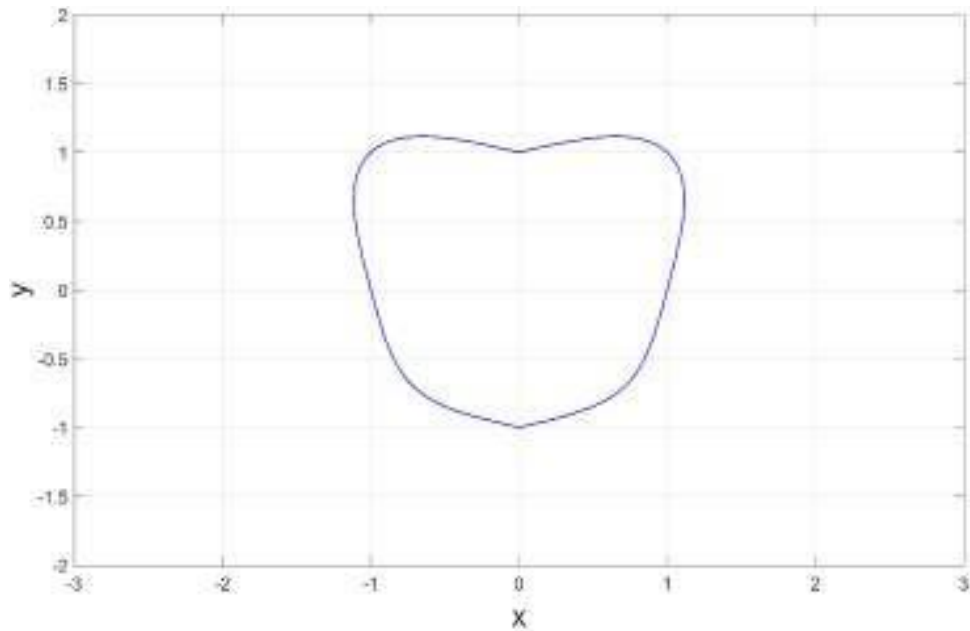

Figure 1. Apple-shaped equilibrium curve for the new chaotic system (1) in the (x, y) – plane

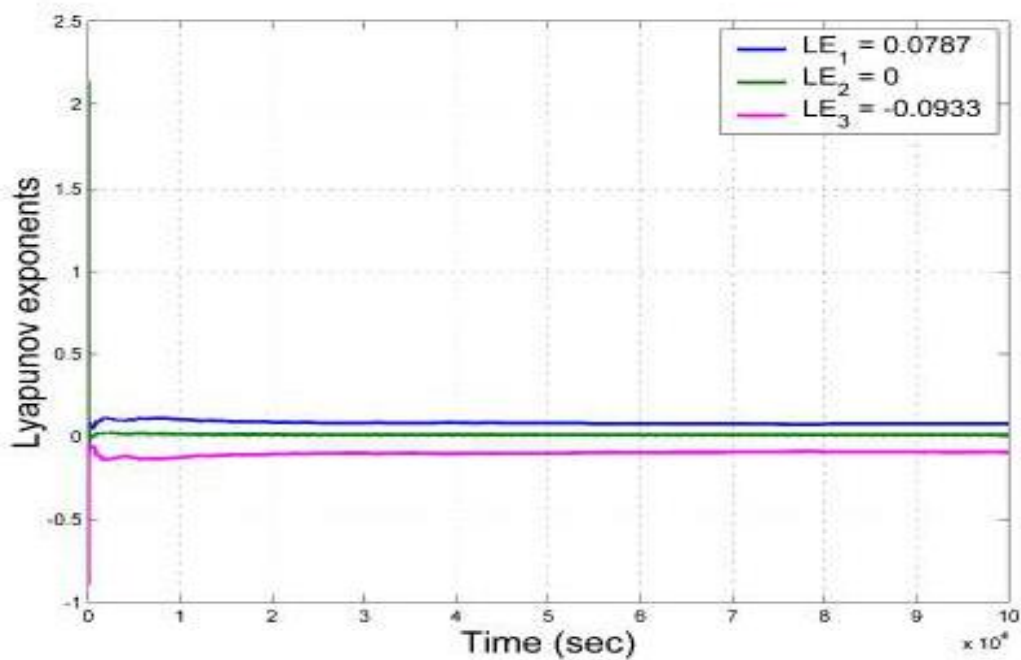

Figure 2. Lyapunov exponents of the new chaotic system (1) for the parameter set $(a,b) = (18,1)$ and initial state $X(0) = (0.01, 0.02, 0.01)$

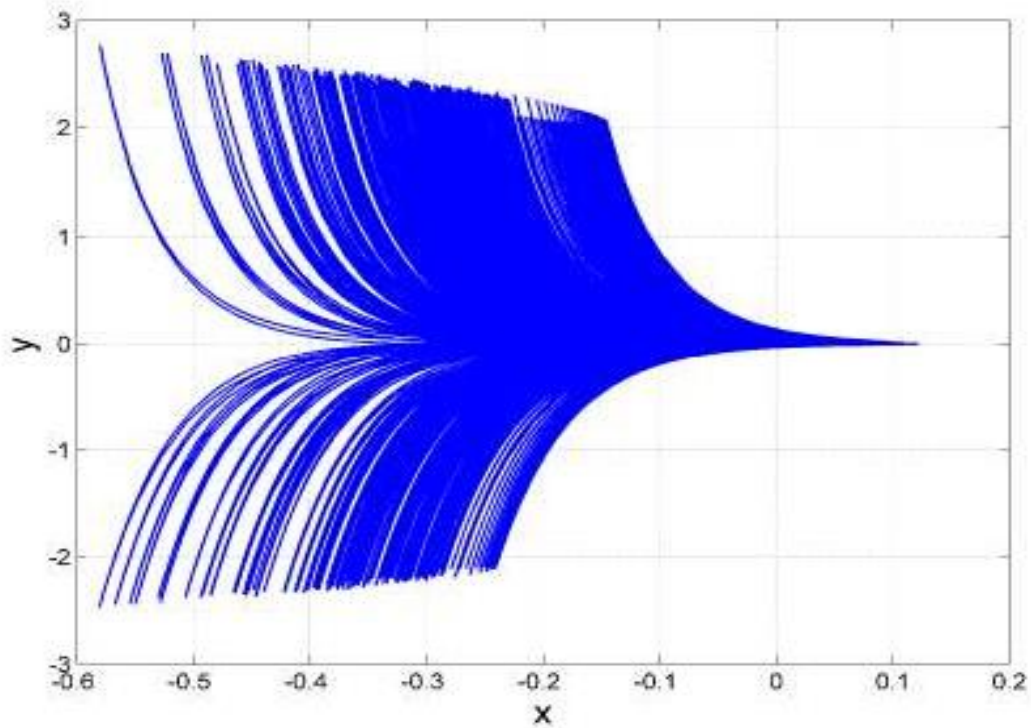

Figure 3. MATLAB plot showing the 2-D phase portrait of the new chaotic system (1) in the (x, y) - plane for $(a, b) = (18, 1)$ and $X(0) = (0.01, 0.02, 0.01)$

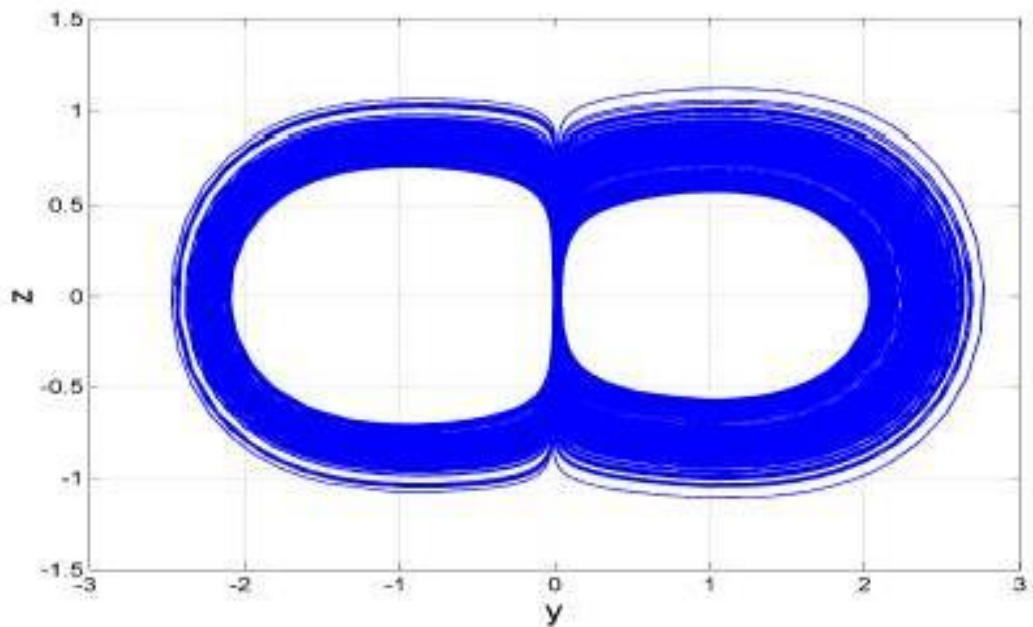

Figure 4. MATLAB plot showing the 2-D phase portrait of the new chaotic system (1) in the (y, z) - plane for $(a, b) = (18, 1)$ and $X(0) = (0.01, 0.02, 0.01)$

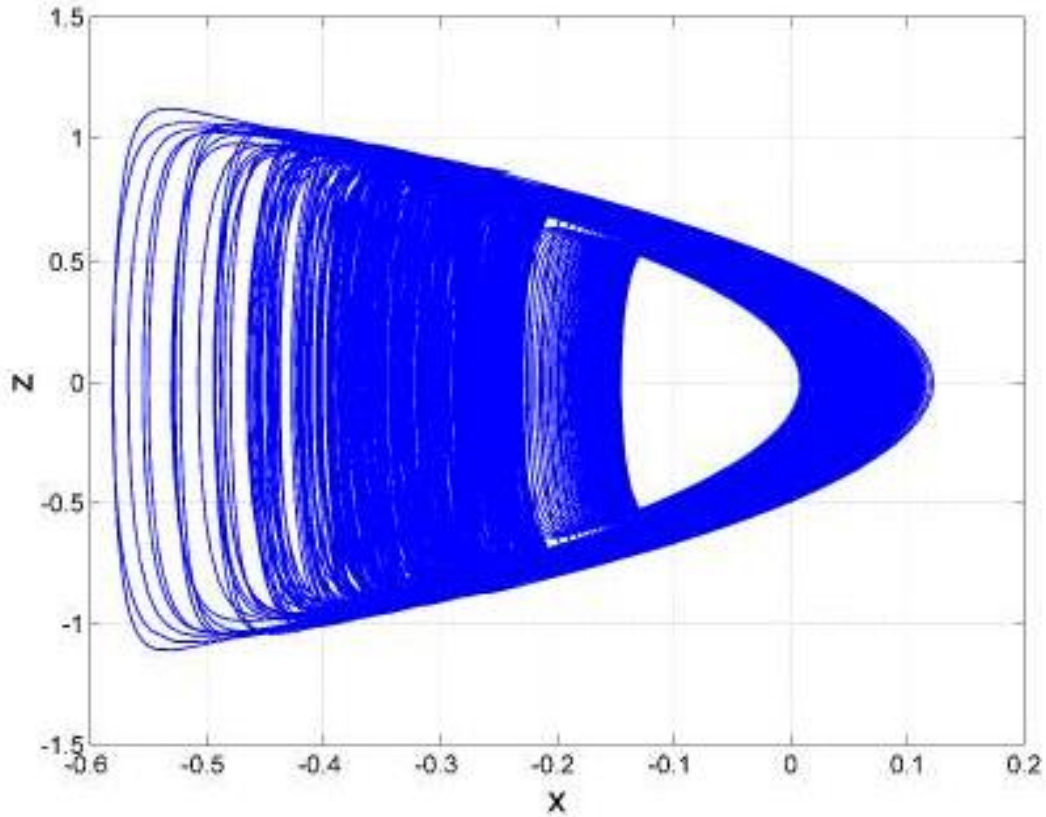

Figure 5. MATLAB plot showing the 2-D phase portrait of the new chaotic system (1) in the (x, z) – plane for $(a,b) = (18,1)$ and $X(0) = (0.01, 0.02, 0.01)$

3. Dynamic Analysis of the New Chaotic System with Apple-Shaped Equilibrium

3.1. Bifurcation Diagram and Lyapunov Exponents for the New Chaotic System

We fix $a = 18$ and vary b in the region of $[0.5, 1.5]$. Figures 6 (a) and 6 (b) show the bifurcation diagram and Lyapunov exponents for the new chaotic system (1), respectively. From Figure 6, we can see that the new system (1) is in robust chaotic state in the whole region of $[0.5, 1.5]$.

3.2. Multi-Stability and Coexisting Attractors for the New Chaotic System

We note that the blue color trajectory starts from the initial state $X(0) = (0.01, 0.02, 0.01)$ and the red color trajectory starts from the initial state $X(0) = (-0.01, -0.02, -0.01)$.

We fix $b = 0.5$ and vary a in the region of $[15, 25]$.

It can be seen from the bifurcation diagram in Figure 7 that there exist coexisting attractors for the new system (1) in the region of $[19, 25]$.

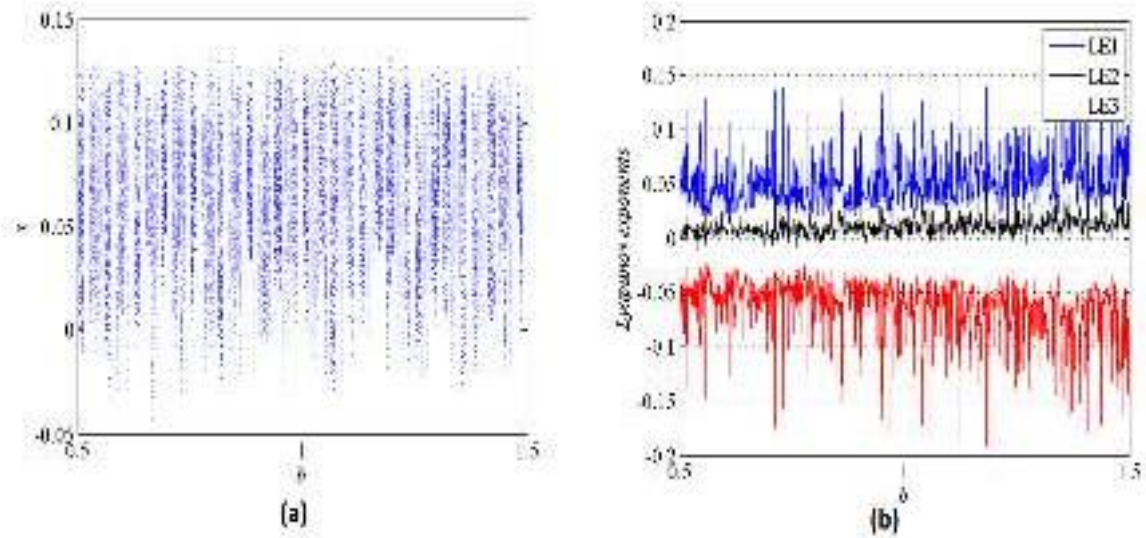

Figure 6. (a) Bifurcation diagram and (b) Lyapunov exponents of the new chaotic system (1), when we fix $a = 18$ and vary b in the region of $[0.5, 1.5]$

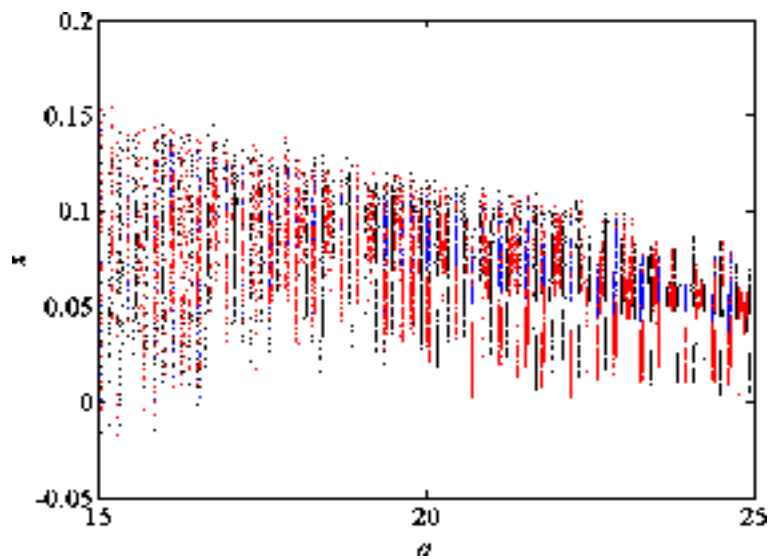

Figure 7. Bifurcation diagram showing coexisting attractors of the new chaotic system (1), when we fix $b = 0.5$ and vary a in the region of $[15, 25]$

Some sample results showing multi-stability and coexisting attractors are detailed next in this section. When $a = 20$, coexisting chaotic attractors exist for the new system (1) as shown in Figure 8.

When $a = 25$, coexisting periodic attractor and chaotic attractor exist for the new system (1) as shown in Figure 9.

When fixing $a = 18, b = 0.5$, the initial conditions $x(0) = 0.01, y(0) = 0.02$ and selecting $z(0)$ for different values, we can obtain multiple coexisting attractors as shown in Figure 10.

In Figure 10, we use $z(0) = 0.01$ for chaos with black color, $z(0) = 0.4$ for chaos with blue color, $z(0) = 0.5$ for periodic trajectory with red color, $z(0) = 0.8$ for periodic trajectory with green color, and $z(0) = 1$ for periodic trajectory with magenta color.

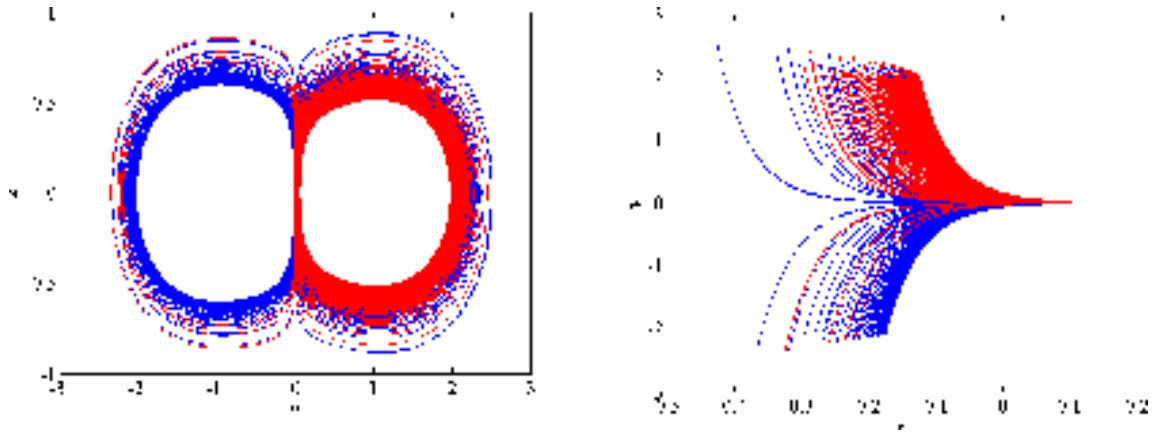

Figure 8. When $a = 20$, coexisting chaotic attractors exist for the new system (1)

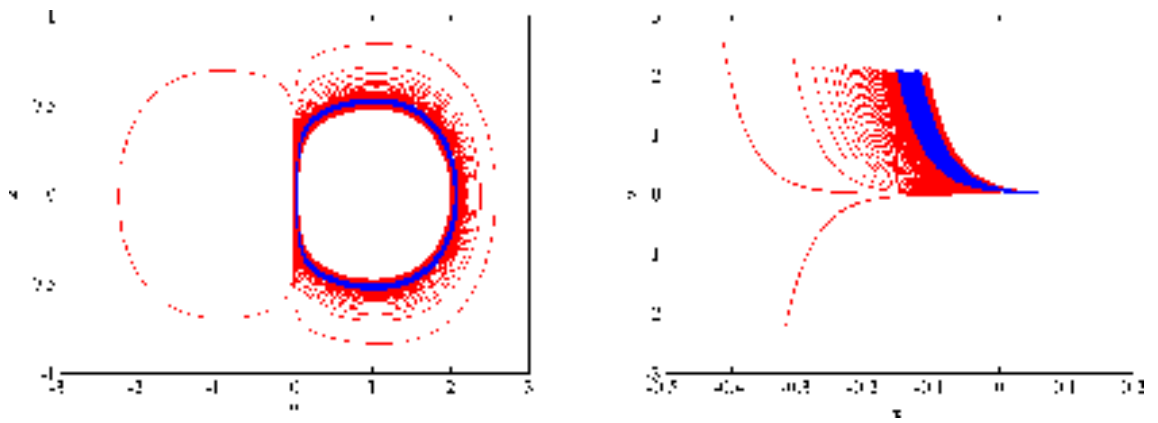

Figure 9. When $a = 25$, coexisting periodic attractor and chaotic attractor exist for the new system (1)

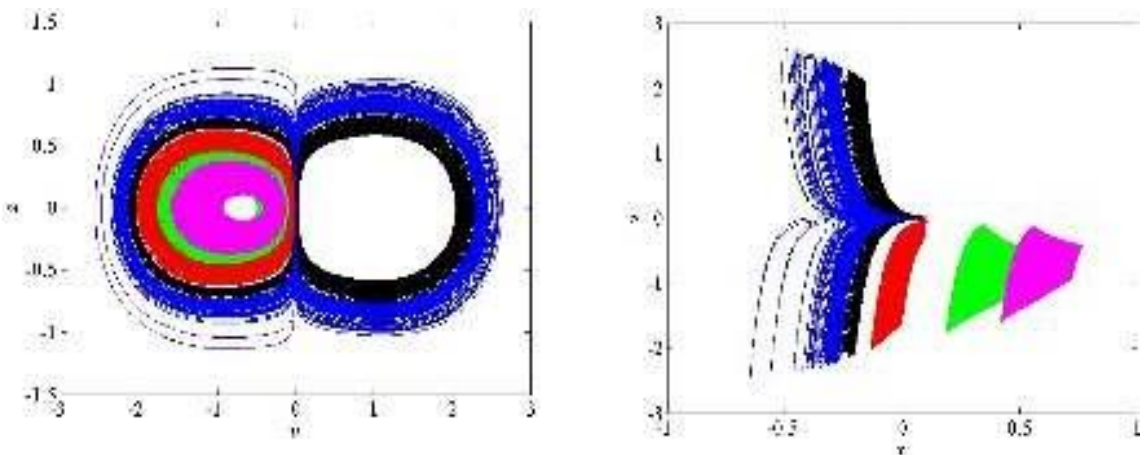

Figure 10. When fixing $a = 18, b = 0.5$, the initial conditions $x(0) = 0.01, y(0) = 0.02$ and selecting $z(0)$ for different values, we can obtain multiple coexisting attractors

4. Circuit Implementation of the New Chaotic System

This section presents the MultiSIM design of an analog circuit in order to approve the theoretical models and confirm the applicability of the mathematical model. To confirm the results practical during the theoretical models, the novel chaotic system with apple shaped equilibrium showed in Figure 11 is simulated in Multisim. The circuit consists of three integrators (U1A, U2A, U3A), three inverters (U4A, U5A, U6A), twelve multipliers AD633JN and an absolute function circuit with two diodes 1N4148.

The three state variables (x, y, z) of the novel chaotic system (1) have been rescaled as $X = 4x, Y = 4y, Z = 4z$. Therefore, the novel chaotic system (1) is converted into the following equivalent system:

$$\begin{cases} \dot{X} = Z \\ \dot{Y} = Z \left(-\frac{aY}{X^4} - \frac{bY^2 - XZ}{4^4} - \frac{16}{16} \right) \\ \dot{Z} = \frac{1}{64} X^4 + \frac{1}{64} Y^4 - \frac{16}{4} |X| - 4 \end{cases} \quad (8)$$

By applying Kirchhoff's laws to this circuit, its dynamics is presented by the following circuit equations:

$$\begin{cases} \dot{X} = -\frac{1}{C_1 R_1} Z \\ \dot{Y} = -\frac{1}{10^3 C_1 R_1} YZ - \frac{1}{10^2 C_1 R_1} Y^2 Z - \frac{1}{10^2 C_1 R_1} XZ^2 \\ \dot{Z} = \frac{1}{10^3 C_1 R_1} X^4 + \frac{1}{10^3 C_1 R_1} Y^4 - \frac{1}{10 C_1 R_1} Y |X| - \frac{1}{C_1 R_1} V_1 \end{cases} \quad (9)$$

where X, Y, Z are the voltages across the capacitors C_1, C_2 and C_3 , respectively. The same value of electronic components used for numerical analysis has been presented for comparison.

The values of the circuit elements were chosen as follows: $R_1 = 400 \text{ k}\Omega, R_2 = 8.889 \text{ k}\Omega, R_3 = R_4 = 64 \text{ k}\Omega, R_5 = R_6 = 25.6 \text{ k}\Omega, R_7 = 160 \text{ k}\Omega, V_1 = 1 \text{ V}_{DC}, R_8 = R_9 = R_{10} = R_{11} = R_{12} = R_{13} = R_{14} = R_{15} = R_{16} = R_{17} = R_{18} = R_{19} = 100 \text{ k}\Omega, C_1 = C_2 = C_3 = 3.2 \text{ nF}$.

The circuit design for the new chaotic system is displayed in Figure 11. MultiSIM simulation of the circuit are displayed in Figures 12-14. The results of electronic circuit are consistent with the theoretical models.

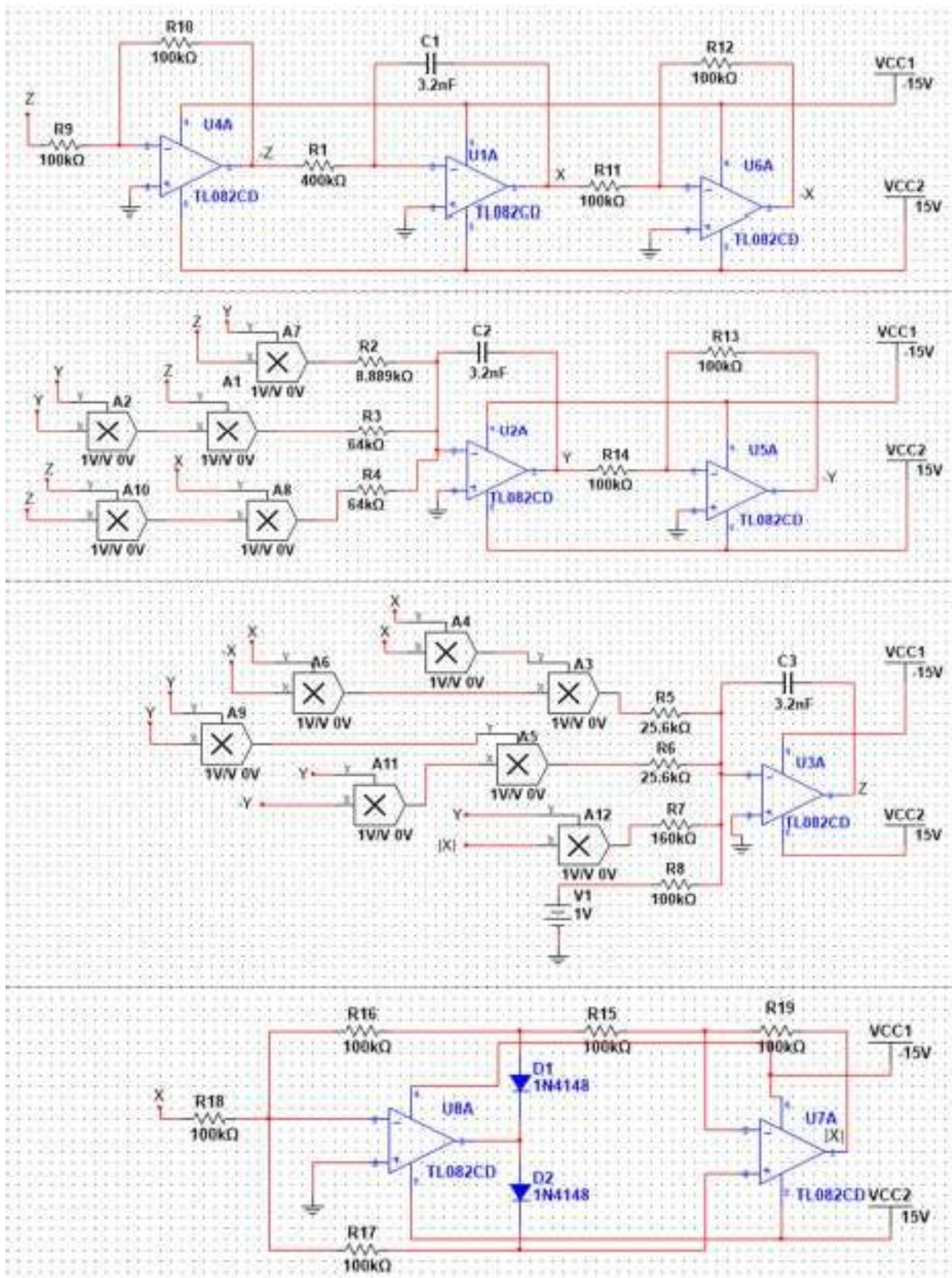

Figure 11. Circuit design for the new chaotic system (1)

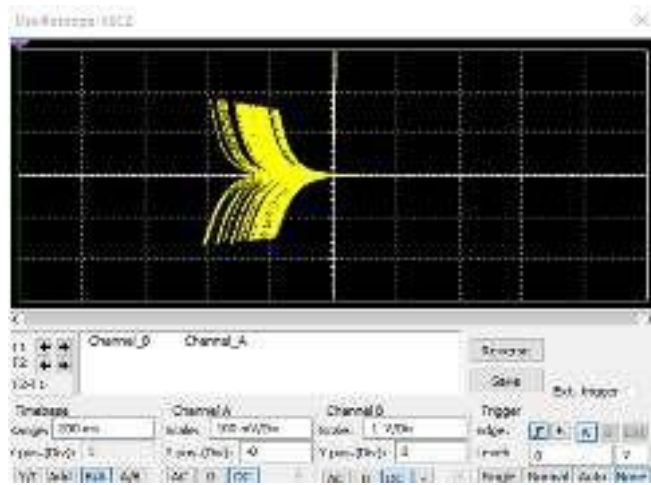

Figure 12. MultiSIM output of the new chaotic system (1) in (x, y) – plane

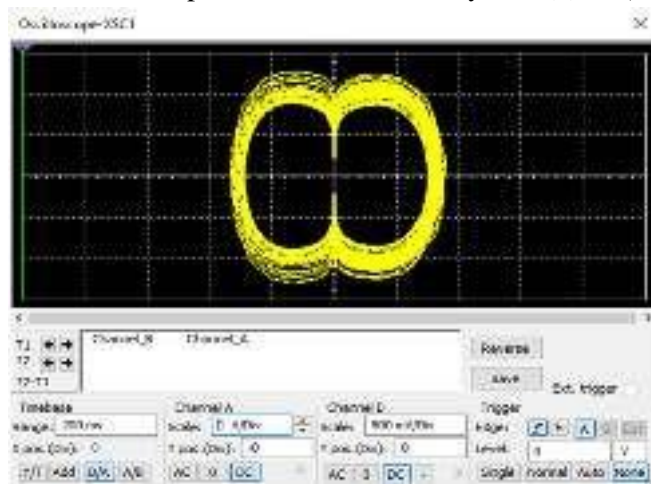

Figure 13. MultiSIM output of the new chaotic system (2) in (y, z) – plane

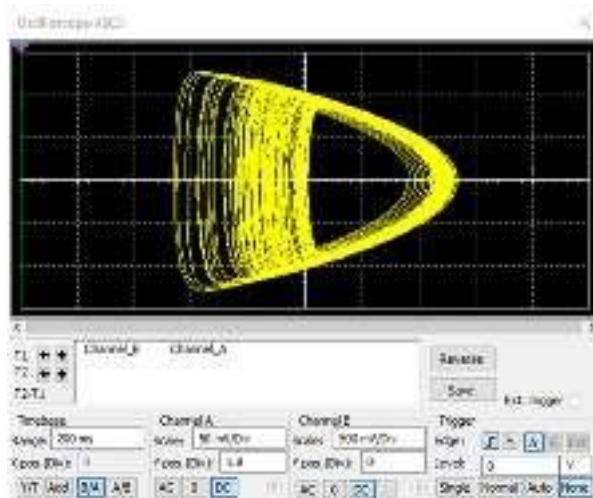

Figure 14. MultiSIM output of the new chaotic system (3) in (x, z) – plane

5. Conclusions

We reported a new 3-D chaotic system with an apple-shaped equilibrium curve in this research work. There is great interest in the literature in discovering chaotic systems with closed curves of equilibrium points. The new 3-D chaotic system proposed in this work has an apple-shaped closed curve of equilibrium points. Since the new chaotic system has an infinite number of equilibrium points, it belongs to the new class of chaotic systems with hidden attractors. We conducted a detailed dynamic analysis of the chaotic system with bifurcation diagram, Lyapunov exponents, phase portraits, etc. We showed that the new chaotic system is multi-stable with coexisting chaotic attractors. As a circuit application, we designed MultiSIM electronic circuit for the new chaotic system. The MultiSIM outputs show good matching with the MATLAB outputs for the new chaotic system.

Acknowledgement

This research was funded Ministry of Research and Higher Education, Republik of Indonesia through Penelitian Kerja Sama Antar Perguruan Tinggi (Grant No. 2891/L4/PP/2019).

References

- [1] Vaidyanathan S and Volos C 2017 *Advances and Applications in Chaotic Systems* (Berlin: Springer)
- [2] Pham V T, Vaidyanathan S, Volos C and Kapitaniak T 2018 *Nonlinear Dynamical Systems with Self-Excited and Hidden Attractors* (Berlin: Springer)
- [3] Sambas A, Vaidyanathan S, Zhang S, Zeng Y, Mohamed M A and Mamat M 2019 *IEEE Access* **7** 115454-115462
- [4] Vaidyanathan S, Dolvis L G, Jacques K, Lien C H and Sambas A 2019 *International Journal of Modelling, Identification and Control* **32** 30-45
- [5] Sambas A, Mamat M, Arafa A A, Mahmoud G M, Mohamed M A and Sanjaya W S M 2019 *International Journal of Electrical and Computer Engineering* **9** 2365-2376
- [6] Leonov G A and Kuznetsov N V 2013 *International Journal of Bifurcation and Chaos* **23** 1330002
- [7] Kuznetsov A P, Kuznetsov S P, Mosekilde E and Stankevich N V 2015 *Journal of Physics A: Mathematical and Theoretical* **48** 125101
- [8] Vaidyanathan S, Sambas A, Mamat M and Sanjaya W S M 2017 *Archives of Control Sciences* **27** 541-554
- [9] Andrievsky B R, Kuznetsov N V, Leonov G A and Pogromsky A Y 2013 *IFAC Proceedings Volumes* **46** 75-79
- [10] Leonov G A, Kuznetsov N V, Kiseleva M A, Solovyeva E P and Zaretskiy A M 2014 *Nonlinear Dynamics* **77** 277-288
- [11] Danca M F and Kuznetsov N 2017 *Chaos, Solitons & Fractals* **103** 144-150
- [12] Jafari S, Pham V T and Kapitaniak T 2016 *International Journal of Bifurcation and Chaos* **26** 1650031
- [13] Wang X and Chen G 2012 *Communications in Nonlinear Science and Numerical Simulation* **17** 1264-1272
- [14] Kingni S T, Pham V T, Jafari S and Woafu P 2017 *Chaos, Solitons & Fractals* **99** 209-218
- [15] Gotthans T and Petrzela 2015 *Nonlinear Dynamics* **81** 1143-1149
- [16] Gotthans T, Sprott J C and Petrzela J 2016 *Int. J. Bifurc. Chaos* **26** 1650137-1650145
- [17] Mobayen S, Vaidyanathan S, Sambas A, Kacar S and Cavusoglu U 2019 *Iranian Journal of Science and Technology – Transactions of Electrical Engineering* **43** 1-9
- [18] Vaidyanathan S, Sambas A, Kacar S and Cavusoglu U 2018 *International Journal of Modelling, Identification and Control* **30** 184-196
- [19] Sambas A, Vaidyanathan S, Mamat M, Mohamed M A and Mada Sanjaya W S 2018 *International Journal of Electrical and Computer Engineering* **8** 4951-4958

- [20] Vaidyanathan S, Sambas A, Zhang S, Zeng Y, Mohamed M A and Mamat M 2019 *Telkomnika* **17** 2465-2474
- [21] Zhang S, Zeng Y, Li Z, Wang M, Zhang X and Chang D 2018 *International Journal of Dynamics and Control* **23** 1-12.
- [22] Zhang S, Zeng Y and Li Z 2018 *Chinese J. Physics* **56** 793-806
- [23] Sambas, A., Vaidyanathan, S., Tlelo-Cuautle, E., Zhang, S., Guillen-Fernandez, O., Sukono, Hidayat, Y and Gundara, G. 2019, *Electronics*, **8**, 1211.
- [24] Wang L, Zhang S, Zeng Y C and Li Z J 2018 *Electronics Letters* **52** 1008-1010
- [25] Wolf A, Swift J B, Swinney H L and Vastano J A 1985 *Physica D* **16** 285-317

Print this page



ICComSET 2019

The 2nd International Conference on Computer, Science,
Engineering and Technology

Universitas Muhammadiyah Tasikmalaya/Banten, 15-16 October 2019

Website: <http://www.2ndiccomset.umtas.ac.id>

Email: iccomset@umtas.ac.id

Date: 08 October 2019

Payment Invoice

Submission Title Electronic Circuit Design of a Novel Chaotic System with Apple-Shaped Curve Equilibrium and Multiple Coexisting Attractors

Authors A. Sambas1*, Sukono2 , S. Zhang3 , S. Vaidyanathan4 , Y. Hidayat5 and Mujiarto1

Registration Type Indonesian Presenter

Payment Amount IDR 2,850,000 (**Not Paid**)

Payment Account	
Bank Name	Bank Syariah Mandiri
Account Number	7142050476
Account Holder	LPPM UMTAS
Info	BSMDIDJAXXX

Note that this document is NOT receipt of payment, please make the payment and then upload your payment proof to the online system.

Best regards,

Anggia Suci Pratiwi, M.Pd.
ICComSET 2019 Finance Manager

[Print this page](#)

ICComSET 2019

The 2nd International Conference on Computer, Science,
Engineering and Technology

Universitas Muhammadiyah Tasikmalaya/Banten, 15-16 October 2019

Website: <http://www.2ndiccomset.umtas.ac.id>

Email: iccomset@umtas.ac.id

Date: 10 October 2019

Payment Receipt

The organizing committee of ICComSET 2019 acknowledges the following payment for registration fee,

Abstract ID ABS-219 (Oral Presentation)

Title "Electronic Circuit Design of a Novel Chaotic System with Apple-Shaped Curve
Equilibrium and Multiple Coexisting Attractors"

Authors A. Sambas^{1*}, Sukono², S. Zhang³, S. Vaidyanathan⁴, Y. Hidayat⁵ and Mujiarto¹

Paid Amount IDR 2,850,000

Paid By Mr. A. Sambas

Thank You.

Best regards,

A handwritten signature in black ink, appearing to read 'Anggia Suci Pratiwi', is written over a faint, light-colored watermark or background graphic.

Anggia Suci Pratiwi, M.Pd.
ICComSET 2019 Finance Manager

Electronic Circuit Design of a Novel Chaotic System with Apple-Shaped Curve Equilibrium and Multiple Coexisting Attractors

A. Sambas^{1*}, Sukono², S. Zhang³, S. Vaidyanathan⁴, Y. Hidayat⁵ and Mujiarto¹

¹Department of Mechanical Engineering, Universitas Muhammadiyah Tasikmalaya, Tasikmalaya, Indonesia

²Department of Mathematics, Faculty of Mathematics and Natural Sciences, Universitas Padjadjaran, Indonesia

³School of Physics and Optoelectric Engineering, Xiangtan University, Xiangtan, Hunan, China

⁴Research and Development Centre, Vel Tech University, Avadi, Chennai, India

⁵Department of Statistics, Faculty of Mathematics and Natural Sciences, Universitas Padjadjaran, Indonesia

*acengs@umtas.ac.id

Abstract. A new 3-D chaotic system with an apple-shaped equilibrium curve is proposed in this research work. There is great interest in the literature in discovering chaotic systems with closed curves of equilibrium points. In this work, we report a new 3-D chaotic system with an apple-shaped closed curve of equilibrium points. We perform a detailed dynamic analysis of the chaotic system with bifurcation diagram, Lyapunov exponents, phase portraits, etc. We show that the new chaotic system is multi-stable with coexisting chaotic attractors. As a circuit application, we design MultiSIM electronic circuit for the new chaotic system. The MultiSIM outputs show good agreement with the MATLAB outputs for the new chaotic system.

1. Introduction

Chaos theory deals with nonlinear dynamical systems exhibiting high sensitivity to small changes in initial conditions [1-2]. Mathematically, chaotic systems are characterized by the presence of at least one positive Lyapunov exponent.

Chaotic systems with hidden attractors have become a hot topic for discussion. The phenomenon of hidden attractors has been applied in various sciences and techniques such as electronic circuit [3-6], radio-physical oscillator system [7], robotic [8], aircraft flight [9], motor DC [10], and Hopfield neural network [11].

In the chaos literature, some important discoveries related to hidden attractors include chaotic system with no equilibrium point [12], system with stable equilibria [13] and system with infinite number of equilibrium [14-20].

In this research paper, we report the finding of a new chaotic system with an apple-shaped curve of equilibrium points. We analyze the properties of the new chaotic system with the help of phase plots, bifurcation diagrams, Lyapunov exponents, etc.

Multi-stability is an important property associated with some chaotic systems, which is basically the co-existence of chaotic attractors for same parameter set but for different initial conditions [21-24]. It is interesting that the new chaotic system has multi-stability with the coexistence of two chaotic attractors for two different initial states.

Section 2 describes the new chaotic system with apple-shaped equilibrium curve, its phase plots and Lyapunov exponents. Chaotic systems with infinite number of equilibrium points belong to the class of chaotic systems with hidden attractors. Thus, the new chaotic system has hidden chaotic attractor. Section 3 describes the dynamic analysis with bifurcation diagrams, Lyapunov exponents and multi-stability of the new chaotic system. Furthermore, an electronic circuit realization of the new chaotic system is presented using MultiSIM in Section 4. The MutiSIM circuit outputs of the new chaotic system in Section 4 show good agreement with the numerical simulations via MATLAB obtained in Section 2. Section 5 draws the main conclusions.

2. A New Chaotic System with Apple-Shaped Equilibrium

In this work, we report a new 3-D system modelled by

$$\begin{cases} \dot{x} = z \\ \dot{y} = z(-ay - by^2 - xz) \\ \dot{z} = x^4 + y^4 - y|x| - 1 \end{cases} \quad (1)$$

where $X = (x, y, z)$ is the state and a, b are positive constants.

In this paper, we show that the 3-D system (1) is *chaotic* for the parameter values $a = 18, b = 1$

Using Wolf's algorithm [60], the Lyapunov exponents of the system (1) for the parameter set $(a, b) = (18, 1)$ and the initial state $X(0) = (0.01, 0.02, 0.01)$ were found as

$$LE_1 = 0.0787, LE_2 = 0, LE_3 = -0.0933 \quad (3)$$

It is noted that the sum of the Lyapunov exponents in (3) is negative.

$$LE_1 + LE_2 + LE_3 = -0.0146 < 0 \quad (4)$$

This shows that the system (1) is dissipative with a strange chaotic attractor. The Kaplan-Yorke dimension of the new chaotic system (1) is computed as

$$D_{KY} = 2 + \frac{LE_1 + LE_2}{|LE_3|} = 2.8435 \quad (5)$$

The high value of the Kaplan-Yorke dimension, D_{KY} , shows the high complexity of the chaotic trajectories of the new 3-D system (1).

The equilibrium points of the new chaotic system (1) are found by solving the system of equations:

$$z = 0 \quad (6a)$$

$$z(-ay - by^2 - xz) = 0 \quad (6b)$$

$$x^4 + y^4 - y|x| - 1 = 0 \quad (6c)$$

Solving the equations (6a)-(6c), we see that the new chaotic system (1) has an apple-shaped closed curve of equilibrium points in the (x, y) -plane given by the set

$$S = \left\{ (x, y, z) \in R^3 \mid z = 0, x^4 + y^4 - y|x| - 1 = 0 \right\} \quad (7)$$

Figure 1 shows the apple-shaped equilibrium curve in the (x, y) -plane for the new chaotic system (1). Figure 2 shows the Lyapunov exponents of the 3-D chaotic system (1) for the parameter set

$(a,b) = (18,1)$ and initial state $X(0) = (0.01, 0.02, 0.01)$. Figures 3-5 show the 2-D phase plots for the new chaotic system (1) for $(a,b) = (18,1)$ and $X(0) = (0.01, 0.02, 0.01)$.

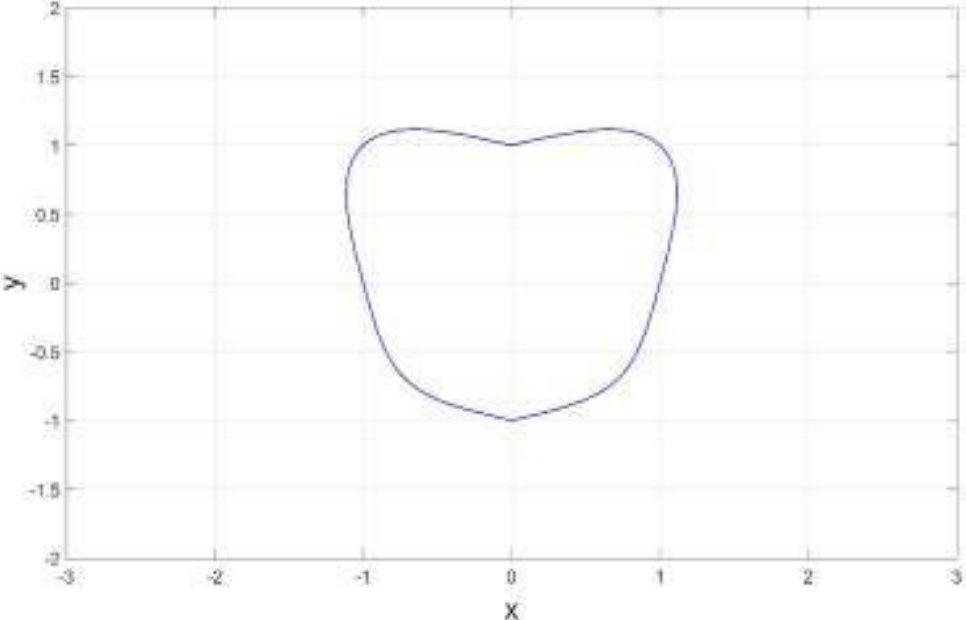

Figure 1. Apple-shaped equilibrium curve for the new chaotic system (1) in the (x, y) – plane

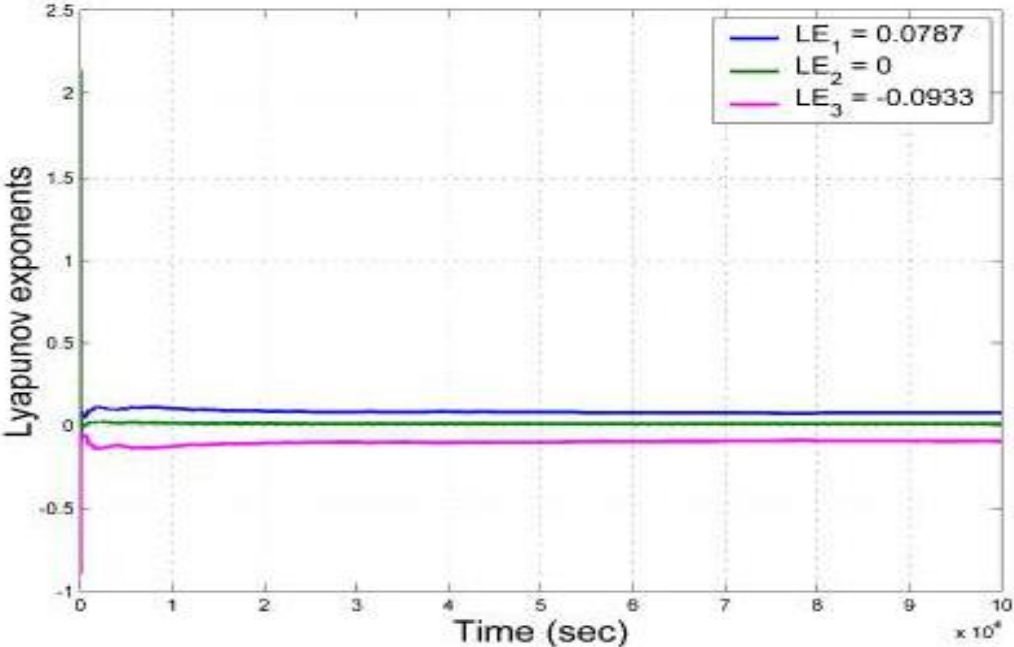

Figure 2. Lyapunov exponents of the new chaotic system (1) for the parameter set $(a,b) = (18,1)$ and initial state $X(0) = (0.01, 0.02, 0.01)$

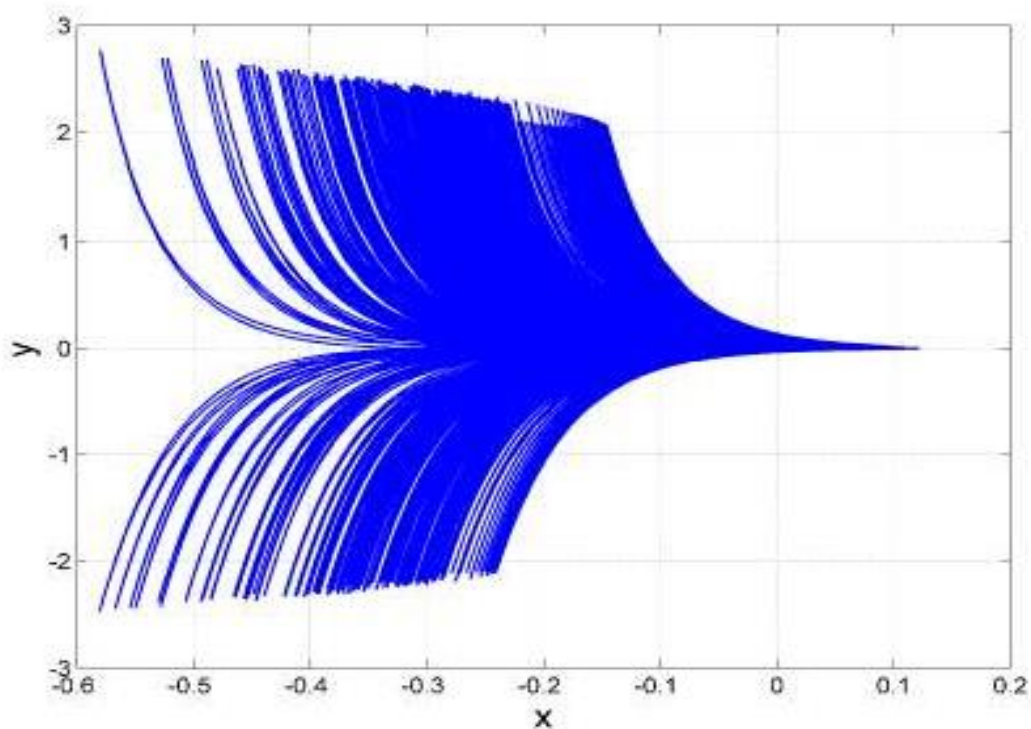

Figure 3. MATLAB plot showing the 2-D phase portrait of the new chaotic system (1) in the (x, y) - plane for $(a, b) = (18, 1)$ and $X(0) = (0.01, 0.02, 0.01)$

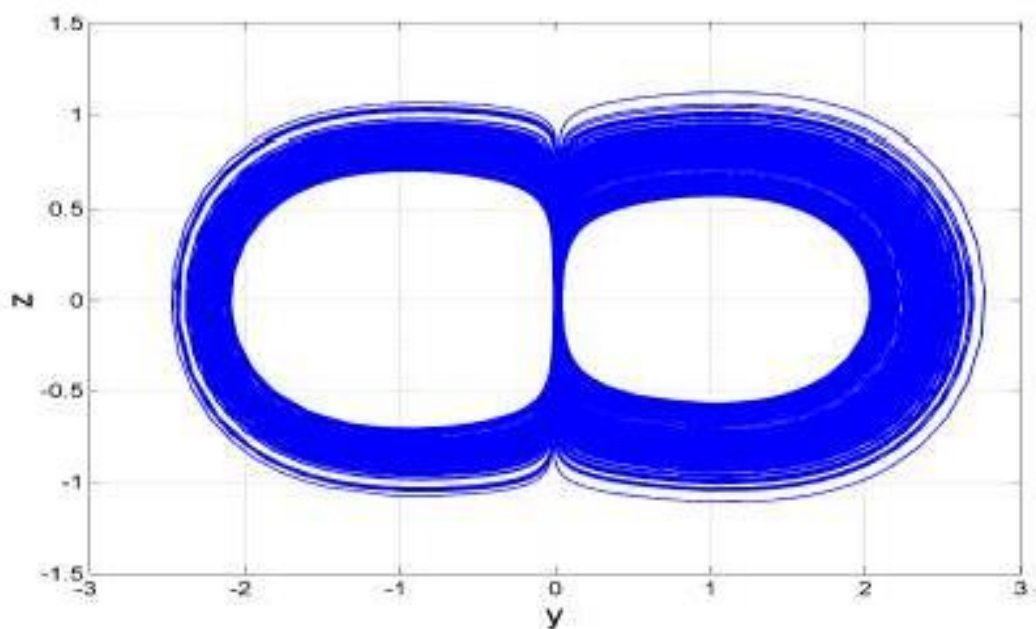

Figure 4. MATLAB plot showing the 2-D phase portrait of the new chaotic system (1) in the (y, z) - plane for $(a, b) = (18, 1)$ and $X(0) = (0.01, 0.02, 0.01)$

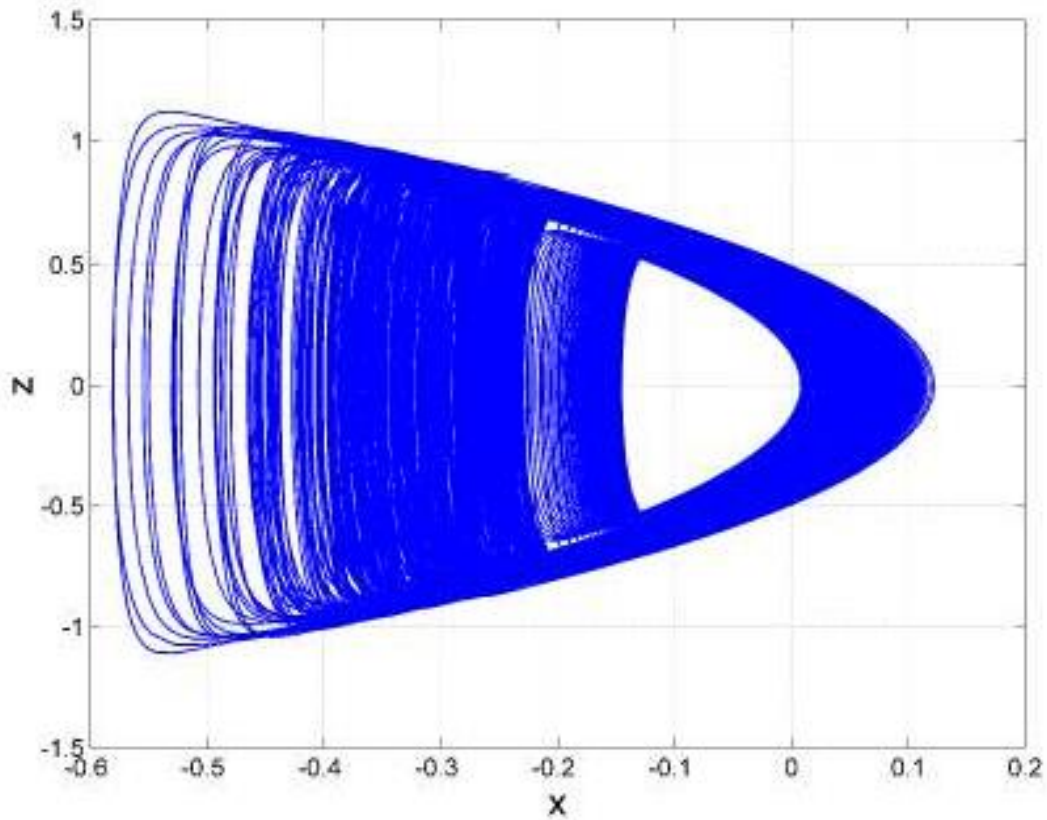

Figure 5. MATLAB plot showing the 2-D phase portrait of the new chaotic system (1) in the (x, z) –plane for $(a, b) = (18, 1)$ and $X(0) = (0.01, 0.02, 0.01)$

3. Dynamic Analysis of the New Chaotic System with Apple-Shaped Equilibrium

3.1. Bifurcation Diagram and Lyapunov Exponents for the New Chaotic System

We fix $a = 18$ and vary b in the region of $[0.5, 1.5]$. Figures 6 (a) and 6 (b) show the bifurcation diagram and Lyapunov exponents for the new chaotic system (1), respectively. From Figure 6, we can see that the new system (1) is in robust chaotic state in the whole region of $[0.5, 1.5]$.

3.2. Multi-Stability and Coexisting Attractors for the New Chaotic System

We note that the blue color trajectory starts from the initial state $X(0) = (0.01, 0.02, 0.01)$ and the red color trajectory starts from the initial state $X(0) = (-0.01, -0.02, -0.01)$.

We fix $b = 0.5$ and vary a in the region of $[15, 25]$.

It can be seen from the bifurcation diagram in Figure 7 that there exist coexisting attractors for the new system (1) in the region of $[19, 25]$.

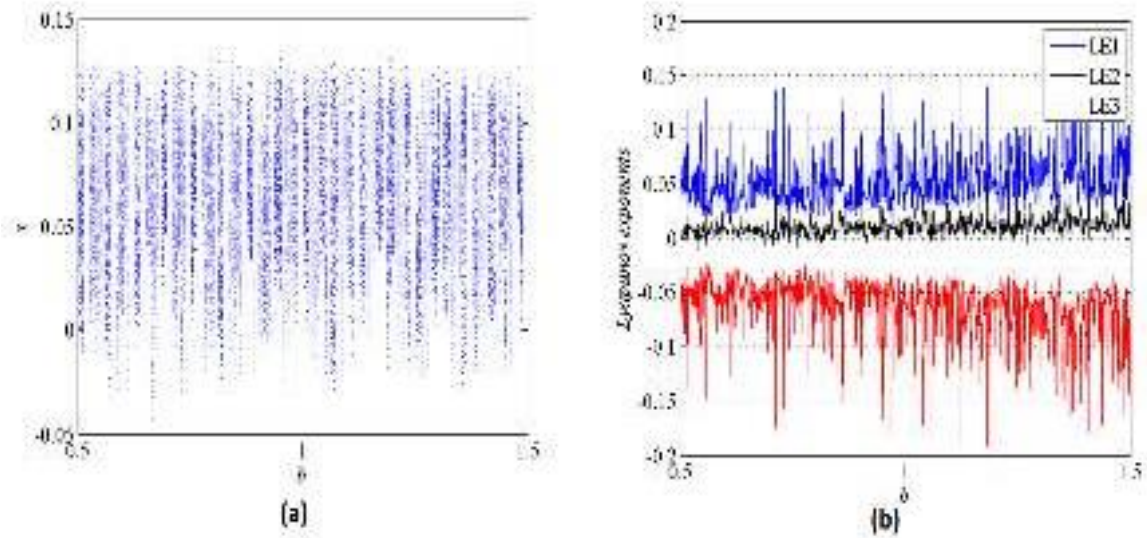

Figure 6. (a) Bifurcation diagram and (b) Lyapunov exponents of the new chaotic system (1), when we fix $a = 18$ and vary b in the region of $[0.5, 1.5]$

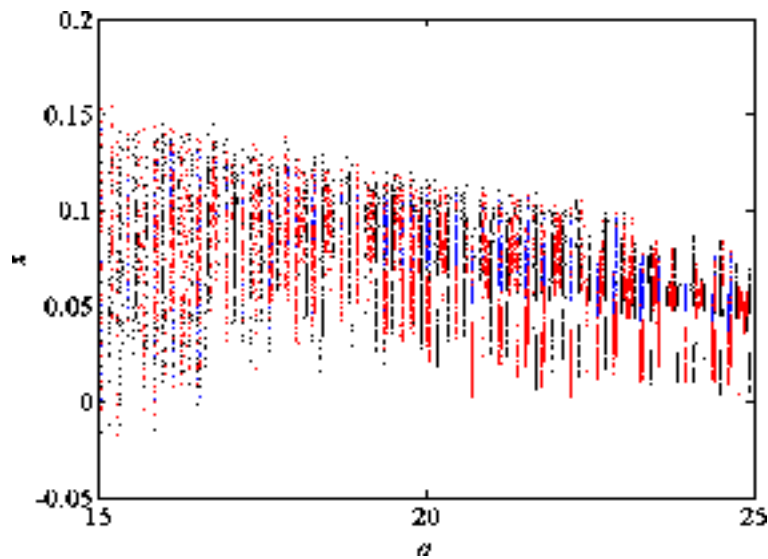

Figure 7. Bifurcation diagram showing coexisting attractors of the new chaotic system (1), when we fix $b = 0.5$ and vary a in the region of $[15, 25]$

Some sample results showing multi-stability and coexisting attractors are detailed next in this section. When $a = 20$, coexisting chaotic attractors exist for the new system (1) as shown in Figure 8.

When $a = 25$, coexisting periodic attractor and chaotic attractor exist for the new system (1) as shown in Figure 9.

When fixing $a = 18, b = 0.5$, the initial conditions $x(0) = 0.01, y(0) = 0.02$ and selecting $z(0)$ for different values, we can obtain multiple coexisting attractors as shown in Figure 10.

In Figure 10, we use $z(0) = 0.01$ for chaos with black color, $z(0) = 0.4$ for chaos with blue color, $z(0) = 0.5$ for periodic trajectory with red color, $z(0) = 0.8$ for periodic trajectory with green color, and $z(0) = 1$ for periodic trajectory with magenta color.

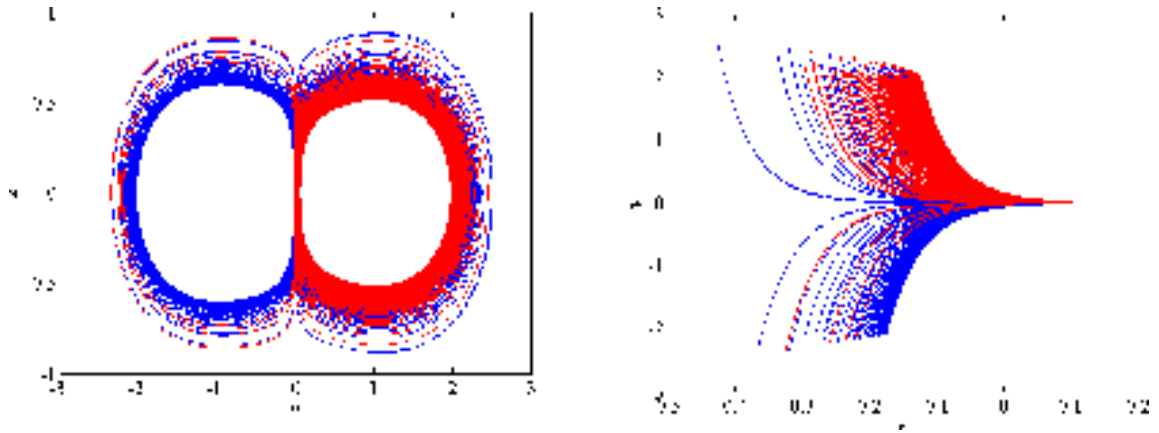

Figure 8. When $a = 20$, coexisting chaotic attractors exist for the new system (1)

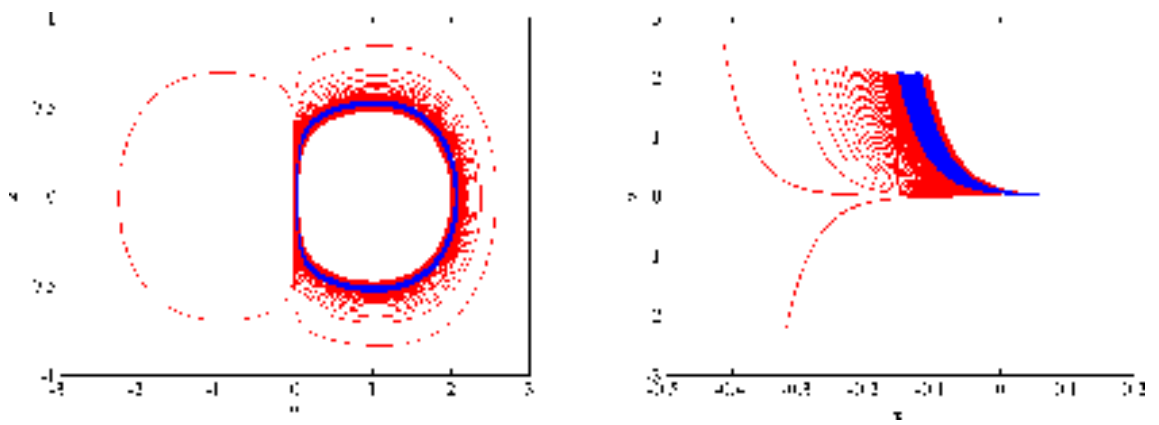

Figure 9. When $a = 25$, coexisting periodic attractor and chaotic attractor exist for the new system (1)

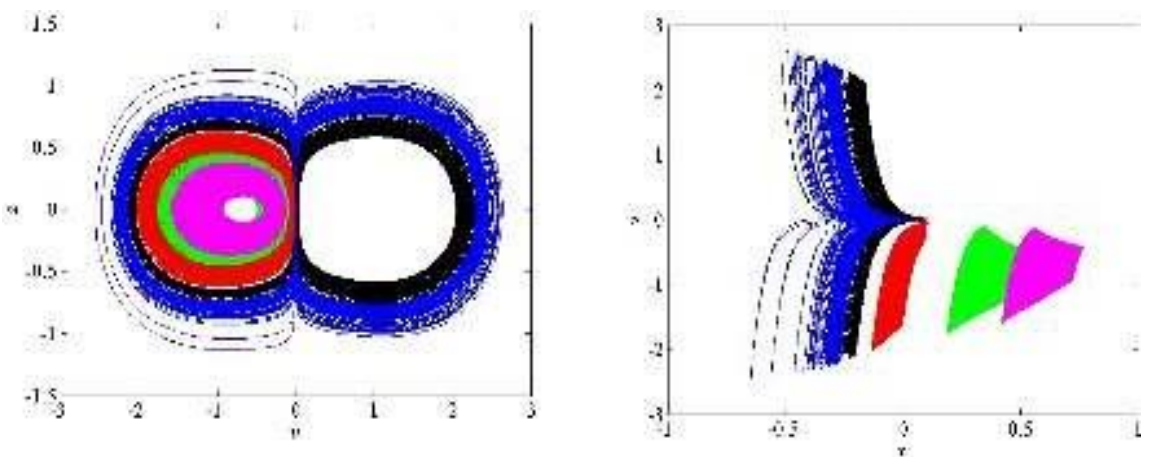

Figure 10. When fixing $a = 18, b = 0.5$, the initial conditions $x(0) = 0.01, y(0) = 0.02$ and selecting $z(0)$ for different values, we can obtain multiple coexisting attractors

4. Circuit Implementation of the New Chaotic System

This section presents the MultiSIM design of an analog circuit in order to approve the theoretical models and confirm the applicability of the mathematical model. To confirm the results practical during the theoretical models, the novel chaotic system with apple shaped equilibrium showed in Figure 11 is simulated in Multisim. The circuit consists of three integrators (U1A, U2A, U3A), three inverters (U4A, U5A, U6A), twelve multipliers AD633JN and an absolute function circuit with two diodes 1N4148.

The three state variables (x, y, z) of the novel chaotic system (1) have been rescaled as $X = 4x, Y = 4y, Z = 4z$. Therefore, the novel chaotic system (1) is converted into the following equivalent system:

$$\begin{cases} \dot{X} = Z \\ \& \left(aY - \frac{bY^2 - XZ}{16} \right) \\ Y = Z \left| -\frac{1}{X^4} - \frac{1}{Y^4} - \frac{1}{16} |X| \right| \\ \& \left(\frac{Z}{64} + \frac{1}{64} - \frac{1}{4} |X| - 4 \right) \end{cases} \quad (8)$$

By applying Kirchhoff's laws to this circuit, its dynamics is presented by the following circuital equations:

$$\begin{cases} \dot{X} = -\frac{1}{C_1 R_1} Z \\ \& \left(-\frac{C_1 R_1}{10^3 C R} YZ - \frac{1}{10^2 C R} Y^2 Z - \frac{1}{10^2 C R} XZ^2 \right) \\ \dot{Z} = \frac{1}{10^3 C R} X^4 + \frac{1}{10^3 C R} Y^4 - \frac{1}{10 C R} Y |X| - \frac{1}{C R} V_1 \end{cases} \quad (9)$$

where X, Y, Z are the voltages across the capacitors C_1, C_2 and C_3 , respectively. The same value of electronic components used for numerical analysis has been presented for comparison.

The values of the circuit elements were chosen as follows: $R_1 = 400 \text{ k}\Omega, R_2 = 8.889 \text{ k}\Omega, R_3 = R_4 = 64 \text{ k}\Omega, R_5 = R_6 = 25.6 \text{ k}\Omega, R_7 = 160 \text{ k}\Omega, V_1 = 1 \text{ V}_{DC}, R_8 = R_9 = R_{10} = R_{11} = R_{12} = R_{13} = R_{14} = R_{15} = R_{16} = R_{17} = R_{18} = R_{19} = 100 \text{ k}\Omega, C_1 = C_2 = C_3 = 3.2 \text{ nF}$.

The circuit design for the new chaotic system is displayed in Figure 11. MultiSIM simulation of the circuit are displayed in Figures 12-14. The results of electronic circuit are consistent with the theoretical models.

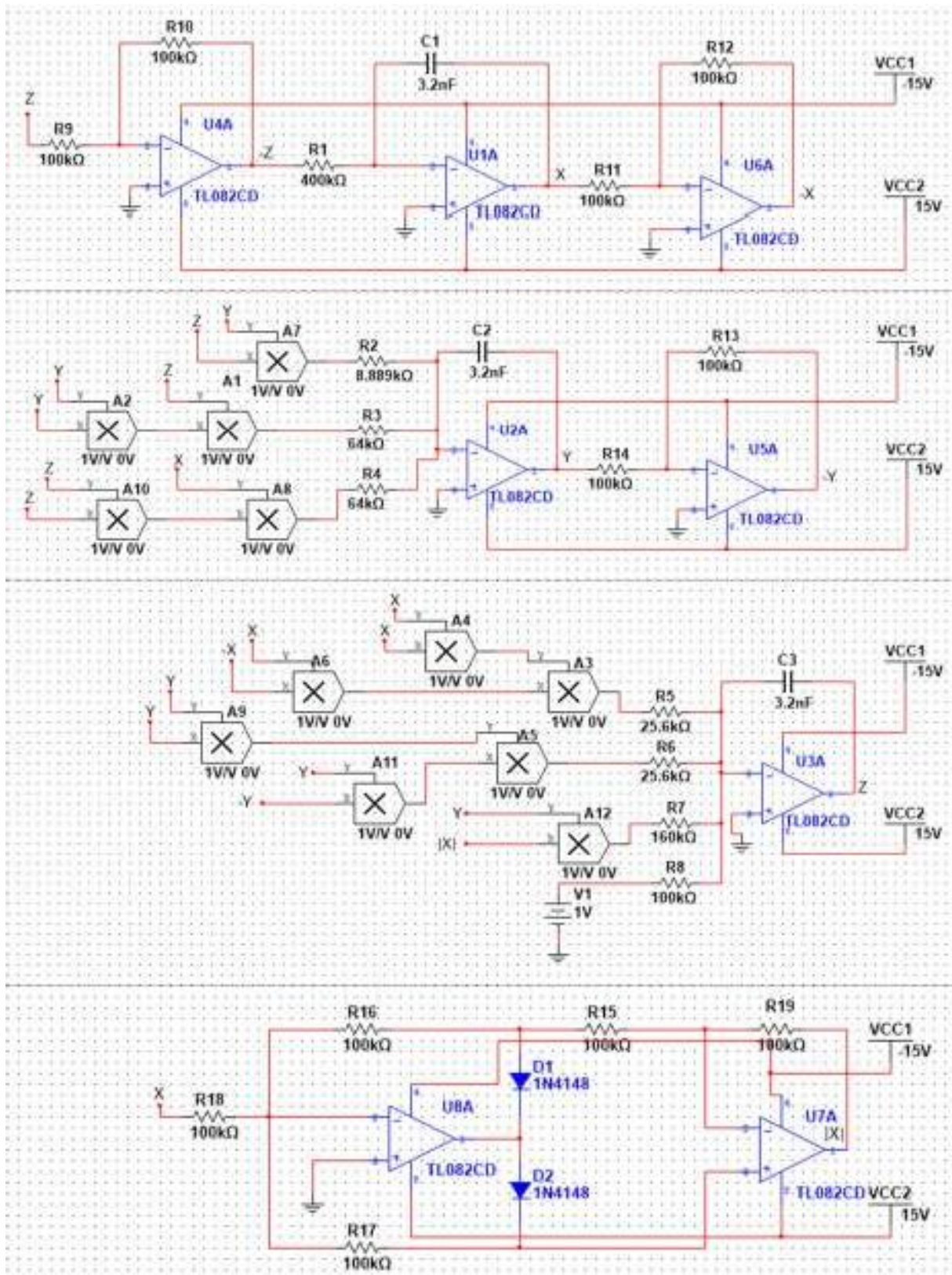

Figure 11. Circuit design for the new chaotic system (1)

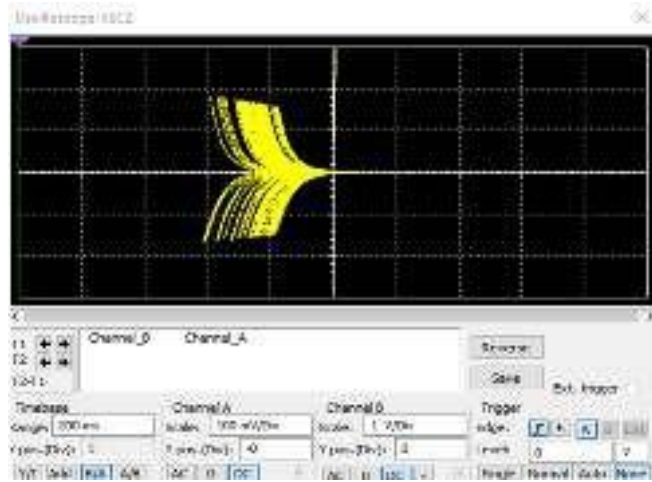

Figure 12. MultiSIM output of the new chaotic system (1) in (x, y) – plane

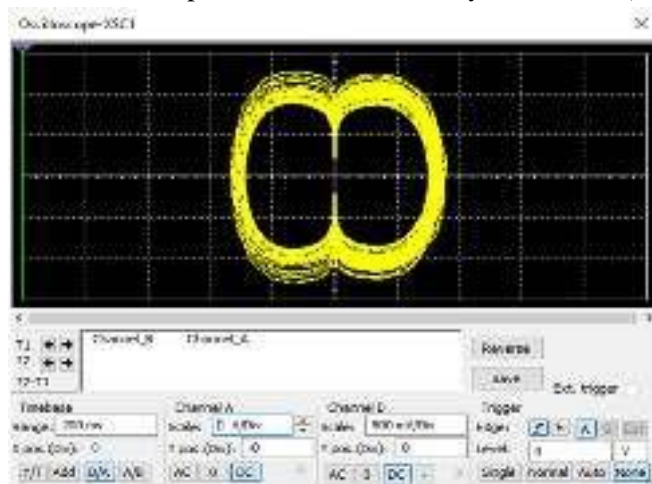

Figure 13. MultiSIM output of the new chaotic system (2) in (y, z) – plane

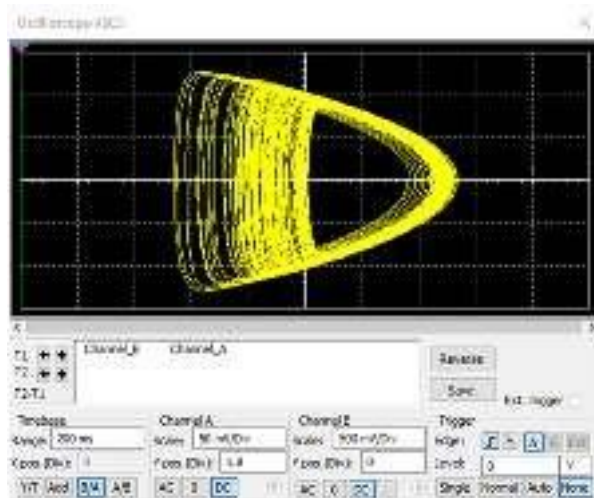

Figure 14. MultiSIM output of the new chaotic system (3) in (x, z) – plane

5. Conclusions

We reported a new 3-D chaotic system with an apple-shaped equilibrium curve in this research work. There is great interest in the literature in discovering chaotic systems with closed curves of equilibrium points. The new 3-D chaotic system proposed in this work has an apple-shaped closed curve of equilibrium points. Since the new chaotic system has an infinite number of equilibrium points, it belongs to the new class of chaotic systems with hidden attractors. We conducted a detailed dynamic analysis of the chaotic system with bifurcation diagram, Lyapunov exponents, phase portraits, etc. We showed that the new chaotic system is multi-stable with coexisting chaotic attractors. As a circuit application, we designed MultiSIM electronic circuit for the new chaotic system. The MultiSIM outputs show good matching with the MATLAB outputs for the new chaotic system.

Acknowledgement

This research was funded Ministry of Research and Higher Education, Republik of Indonesia through Penelitian Kerja Sama Antar Perguruan Tinggi (Grant No. 2891/L4/PP/2019).

References

- [1] Vaidyanathan S and Volos C 2017 *Advances and Applications in Chaotic Systems* (Berlin: Springer)
- [2] Pham V T, Vaidyanathan S, Volos C and Kapitaniak T 2018 *Nonlinear Dynamical Systems with Self-Excited and Hidden Attractors* (Berlin: Springer)
- [3] Sambas A, Vaidyanathan S, Zhang S, Zeng Y, Mohamed M A and Mamat M 2019 *IEEE Access* **7** 115454-115462
- [4] Vaidyanathan S, Dolvis L G, Jacques K, Lien C H and Sambas A 2019 *International Journal of Modelling, Identification and Control* **32** 30-45
- [5] Sambas A, Mamat M, Arafa A A, Mahmoud G M, Mohamed M A and Sanjaya W S M 2019 *International Journal of Electrical and Computer Engineering* **9** 2365-2376
- [6] Leonov G A and Kuznetsov N V 2013 *International Journal of Bifurcation and Chaos* **23** 1330002
- [7] Kuznetsov A P, Kuznetsov S P, Mosekilde E and Stankevich N V 2015 *Journal of Physics A: Mathematical and Theoretical* **48** 125101
- [8] Vaidyanathan S, Sambas A, Mamat M and Sanjaya W S M 2017 *Archives of Control Sciences* **27** 541-554
- [9] Andrievsky B R, Kuznetsov N V, Leonov G A and Pogromsky A Y 2013 *IFAC Proceedings Volumes* **46** 75-79
- [10] Leonov G A, Kuznetsov N V, Kiseleva M A, Solovyeva E P and Zaretskiy A M 2014 *Nonlinear Dynamics* **77** 277-288
- [11] Danca M F and Kuznetsov N 2017 *Chaos, Solitons & Fractals* **103** 144-150
- [12] Jafari S, Pham V T and Kapitaniak T 2016 *International Journal of Bifurcation and Chaos* **26** 1650031
- [13] Wang X and Chen G 2012 *Communications in Nonlinear Science and Numerical Simulation* **17** 1264-1272
- [14] Kingni S T, Pham V T, Jafari S and Wofo P 2017 *Chaos, Solitons & Fractals* **99** 209-218
- [15] Gotthans T and Petrzela 2015 *Nonlinear Dynamics* **81** 1143-1149
- [16] Gotthans T, Sprott J C and Petrzela J 2016 *Int. J. Bifurc. Chaos* **26** 1650137-1650145
- [17] Mobayen S, Vaidyanathan S, Sambas A, Kacar S and Cavusoglu U 2019 *Iranian Journal of Science and Technology – Transactions of Electrical Engineering* **43** 1-9
- [18] Vaidyanathan S, Sambas A, Kacar S and Cavusoglu U 2018 *International Journal of Modelling, Identification and Control* **30** 184-196
- [19] Sambas A, Vaidyanathan S, Mamat M, Mohamed M A and Mada Sanjaya W S 2018 *International Journal of Electrical and Computer Engineering* **8** 4951-4958

- [20] Vaidyanathan S, Sambas A, Zhang S, Zeng Y, Mohamed M A and Mamat M 2019 *Telkomnika* **17** 2465-2474
- [21] Zhang S, Zeng Y, Li Z, Wang M, Zhang X and Chang D 2018 *International Journal of Dynamics and Control* **23** 1-12.
- [22] Zhang S, Zeng Y and Li Z 2018 *Chinese J. Physics* **56** 793-806
- [23] Sambas, A., Vaidyanathan, S., Tlelo-Cuautle, E., Zhang, S., Guillen-Fernandez, O., Sukono, Hidayat, Y and Gundara, G. 2019, *Electronics*, **8**, 1211.
- [24] Wang L, Zhang S, Zeng Y C and Li Z J 2018 *Electronics Letters* **52** 1008-1010
- [25] Wolf A, Swift J B, Swinney H L and Vastano J A 1985 *Physica D* **16** 285-317

[Print this page](#)

ICComSET 2020

The 3rd International Conference on Computer, Science, Engineering and Technology

Universitas Muhammadiyah Tasikmalaya/Virtually, 22 December 2020

Website: <http://www.3rdicomset.umtas.ac.id>

Email: icomset@umtas.ac.id

Date: 11 October 2022

Letter of Acceptance for Abstract

Dear Authors: A. Sambas1*, Sukono2 , S. Zhang3 , S. Vaidyanathan4 , Y. Hidayat5 and Mujiarto1

We are pleased to inform you that your abstract (ABS-219, Oral Presentation), entitled:

"Electronic Circuit Design of a Novel Chaotic System with Apple-Shaped Curve Equilibrium and Multiple Coexisting Attractors"

has been reviewed and accepted to be presented at ICComSET 2020 conference to be held on 22 December 2020 in Tasikmalaya, Indonesia.

Please submit your full paper and make the payment for registration fee before the deadlines, visit our website for more information.

Thank You.

Best regards,

A handwritten signature in black ink, appearing to read "Mujiarto".

Dr. Mujiarto, S.T.,M.T.
ICComSET 2020 Chairperson



Konfrenzi.com - Conference Management System